

① Upper Saddle

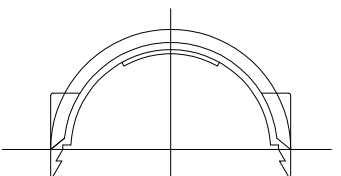

② Lower Saddle

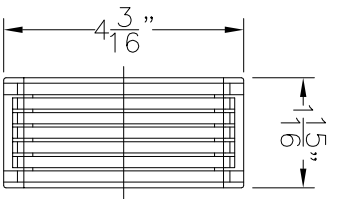
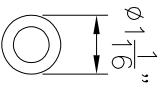
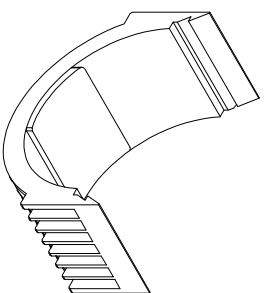

③ O-Ring

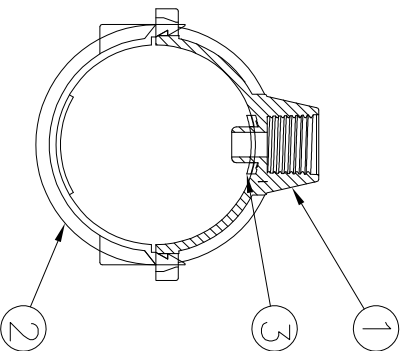

PART No.	PART NAME	MATERIAL	Q'TY	REMARKS
3	O-Ring	PP	1	
2	Lower Saddle	PP	1	
1	Upper Saddle	PP	1	

QTS389 SADDLE

SCALE : NTS

DATE :05/24/21

DRAWN BY : -----
 DWG No. QTS389
 MODEL QTS389